

---

## General Purpose Pressure Transmitter with Ceramic cell

**Model :** P115 (Circular Connector)  
P116 (DIN Connector)  
P117 (Flying Leads)  
P118 (General Head)



### Advantages

General purpose transmitter for industrial applications

- Extremely corrosion resistant
- Measuring ranges from 0.5 to 500kgf/cm<sup>2</sup>
- Rugged piezoresistive ceramic measuring cell
- Shock and vibration resistant

### Applications

The transmitters can be used for a wide range of applications in process control, automatic machinery and hydraulic or pneumatic system design.

- Standard hydraulic and pneumatic equipments
- Process control
- Machine tools and automatic machinery
- Monitoring systems
- Servo valves and drives
- Chemical and petrochemical industry
- Air and gas compressors
- Loading and brake systems



P115



P116



P117



P118

### Descriptions

P110 series pressure transmitter has been designed as an advanced device for measuring pressure of gases and liquids in industrial applications. It is extremely versatile and suitable for measuring static pressure. The built-in ceramic measuring cell is highly corrosion resistant, stable and has an excellent price / performance ratio. Thanks to their high natural frequency and the rugged construction, the P110 transmitter withstands high shock and vibration. The transmitters are available as absolute and relative pressure types with either 2-wire current or 3-wire voltage output.

The pressure to be measured acts without transmitting liquid fill on a stable, corrosion resistant ceramic measuring cell. Piezoresistive resistors are attached to the cell and connected in a Wheatstone bridge configuration. The output signal of this bridge is converted into a standardized current or voltage output signal.

## Specification

Input				
Technology	Piezoresistive ceramic pressure sensor			
Pressure ranges	0~0.5 to 0~500kgf/cm <sup>2</sup> absolute or gauge pressure			
Pressure reference	Gauge, absolute, vacuum and compound			
Overload	1.5x full scale without damage			
Output				
	Unamplified		Unamplified	
Electrical connection type	2-wire technique		3 or 4-wire technique	
Full scale output signal	20mA	±0.5%	5V	±0.5%
Zero measured output	4mA	±0.05%	1V	±0.05%
	Other signals available on request			
Electrical Specification				
Excitation voltage	24V DC(12~36V DC)			
Load resistance max @ 24V	500Ω at 24V			
Influence of excitation	0.01% FSO/V			
Power ripple	≤500mV P-P			
Reverse polarity	Protected			
Shock resistance	≤20g			
Response time(10~90%)	1.5ms			
Adjustment	±10% FSO/zero and span (Fixed value by default)			
Performance Specification				
Accuracy	≤ ±0.5% FSO			
Linearity, Hysteresis & Repeatability	±0.2% FSO typical			
Stability	±0.3% FSO/a @25°C			
Cutoff frequency(-3 d B)	≤ 2KHz			
Reference temperature	25°C			
Operating temperature range	0~60°C			
Storage temperature range	-20~70°C			
Thermal sensitivity shift	≤ ±0.015%/°C typical			
Thermal zero shift	≤ ±0.02% FSO/°C typical			
Physical Specification				
Process connection	PT1/4 , PT3/8 , PT1/2 male thread			
	PF1/4 , PF3/8 , PF1/2 male thread			
	Female thread & other connections available on request			
Process media	Gases and liquids compatible with ceramic Al <sub>2</sub> O <sub>3</sub> , 96%			
Materials	Diaphragm : Ceramic Al <sub>2</sub> O <sub>3</sub> , 96%			
	Housing (Body) : Stainless steel 304			
	Process connection : Stainless steel 316			
	Terminal head for P118 Model : Aluminium Die-casting (ALDC)			
	Gasket O-ring : Viton (HNBR, CSM, etc.)			
Enclosure rating	IP65			
Influence of mounting position	Not critical			
Weight	Approx. (270g)			
Options	Cooling Fin			
	Siphon tube			

- Note :
- ① Cable version : 1.5m standard length, 4-wire, shielded with integral vent tube
  - ② Vented gauge units must breathe dry, non - corrosive gases.
  - ③ Connector version is vented through the removed pin, cable versions are vented through a vent tube inside the cable sleeve

## System connection for 2-wire transmitter

## System connection for 3-wire transmitter

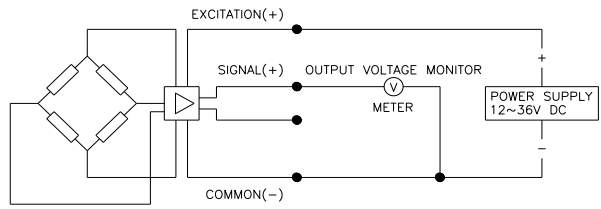
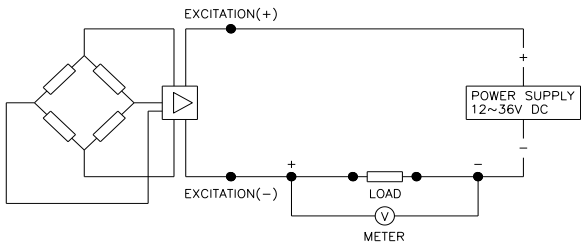

## Dimension (mm)

## Electrical connection

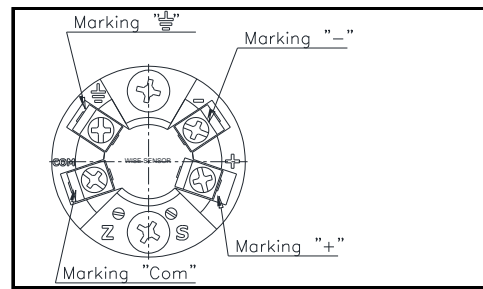
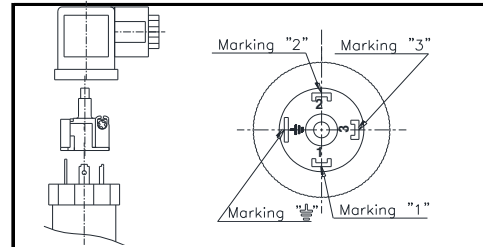
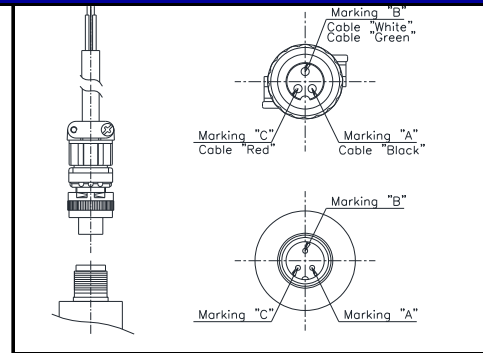
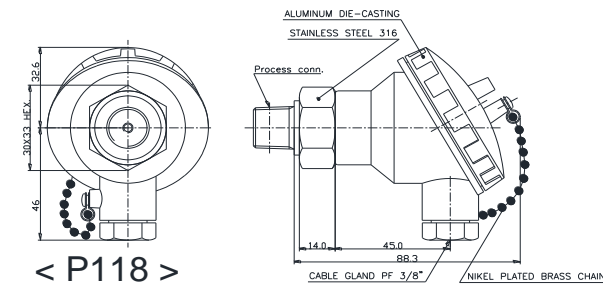
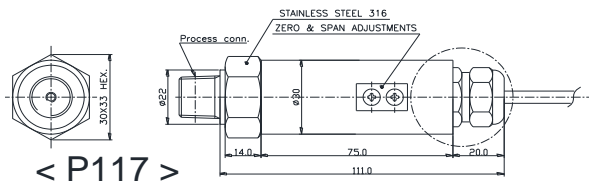
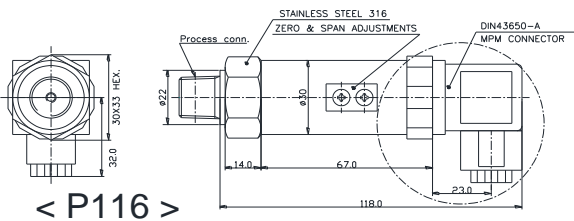
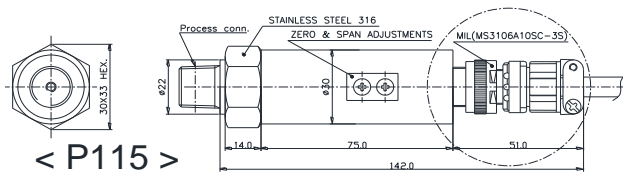

### • Wiring diagrams

E : Excitation

S : Signal

C : Common

Conn.	System	Wire		
		2	3	4
P 1 1 5	Red	E +	E +	E +
	Black	E -	C -	E -
	Green		S +	S +
	White			S -
	GND	Shielded	Shielded	Shielded
P 1 1 6	1	E +	E +	E +
	3	E -	C -	E -
	4		S +	S +
	GND	Shielded	Shielded	S -

Conn.	System	Wire		
		2	3	4
P 1 1 7	Red	E +	E +	E +
	Black	E -	C -	E -
	Green		S +	S +
	White			S -
	GND	Shielded	Shielded	Shielded
P 1 1 8	+	E +	E +	E +
	-	E -	C -	E -
	Com		S +	S +
	GND	Shielded	Shielded	S -

## Ordering Information

### General Purpose Pressure Transmitter

#### 1. Base model

P115										Circular Connector
P116										DIN Connector
P117										Flying lead(1.5m cable)
P118										General Head

#### 2. Pressure reference

R										Relative pressure
A										Absolute pressure

#### 3. Process connection type "1"

M										Male thread
F										Female thread

#### 4. Process connection type "2"

T										PT thread as standard
N										NPT thread
F										PF thread
X										Other process connections available on request

#### 5. Process connection size

1										1/4"
2										3/8"
3										1/2"
X										Other units available on request

#### 6. Accuracy

S										±0.5% F.S.O
---	--	--	--	--	--	--	--	--	--	-------------

#### 7. Measuring range

01										0 ~ 0.5 kg/cm <sup>2</sup>
02										0 ~ 1
03										0 ~ 2
04										0 ~ 5
05										0 ~ 10
06										0 ~ 20
07										0 ~ 35
08										0 ~ 50
09										0 ~ 100
10										0 ~ 200
11										0 ~ 350
12										0 ~ 500
xx										Other calibration ranges available on request

#### 8. Unit

K										Calibration in kgf/cm <sup>2</sup>
A										Calibration in Mpa
B										Calibration in bar
P										Calibration in psi
X										Other units available on request

#### 9. Output signal / Electrical connection type

A1										4~20mA, DC, 2-wire output
A2										4~20mA, DC, 4-wire output
B1										1~5V, DC, 3-wire output
B2										0~5V, DC, 3-wire output (Only available P116 and P117)
B3										0~10V, DC, 3-wire output (Only available P116 and P117)

#### 10. Option

N										None options
C										Cooling Fin
S										Siphon tube
X										Other accessories available on request

P115	R	M	T	2	S	01	K	A1	N	Sample ordering code
------	---	---	---	---	---	----	---	----	---	----------------------

Specifications subject to change without notice